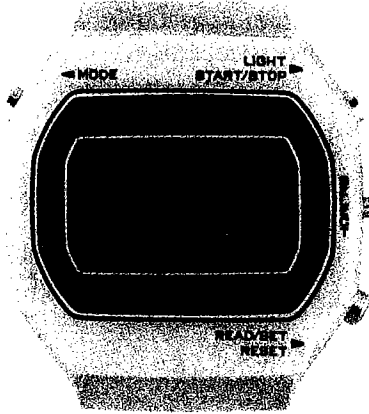

***TECHNICAL
INFORMATION***

**CITIZEN QUARTZ
Cal.No.910※※**

 **CITIZEN**

§1. OUTLINE

This is digital quartz crystal watch with LC display, which features multiple functions including alarm 1 and 2, time signal, reverse operation timer and stop-watch, in addition to the ordinary display of "hour", "minute", "second" and "AM/PM" plus the calendar display of "month", "date" and "day" respectively. Thus, it excels both in the design and performance for a wristwatch.

The Cal No. 9101A incorporates additionally the time announcement device through which the time is announced in three different kinds of tones.

§2. FEATURES**1) Digital quartz crystal watch with multi-function:**

In addition to the normal display ("hour", "minute", "second", "AM/PM") and calendar display ("month", "date", "day"), the following functions are added: alarm-1 and alarm-2 which can be set independently with each other; chime which gives alarm sound twice simultaneously with the time signal; timer mechanism which can set down to second; and stopwatch mechanism which is capable of continuous measurement.

2) Alarm monitor:

The electronic alarm tone can be heard with simultaneous push of both **(R)** and **(L)** buttons under the normal display mode.

3) Mode mark indication:

The mode marks are used to indicate the set modes for quick confirmation of the following functions: alarm-1, alarm 2, chime, timer mechanism and stopwatch mechanism.

4) Built-in illumination lamp:

A built-in illumination lamp facilitates an easy and clear time readout even in the dark.

5) Automatic calendar setting system:

The calendar can be set automatically at the end of each month (excluding the leap years).

6) Power cell life indicating device:

The colon on the time screen flashes to indicate replacement of the power cell.

7) Uninterrupted operation about two years by a small-size silver oxide power cell:

The reduction of the power consumption at the electronic circuit part makes it possible to operate the watch accurately for about two years with a small-size silver oxide power cell.

(Main Features of Cal. No. 9101A)

8) Automatic calendar setting system:

The calendar can be set automatically at the end of each month and year including the leap years.

9) Unique time announcement device:

The time announcement device announces the user the time in three different kinds of alarm tones and through one-touch operation of push-buttons.

§ 3. HANDLING INSTRUCTION

Cal. 9100A

1) Operational modes

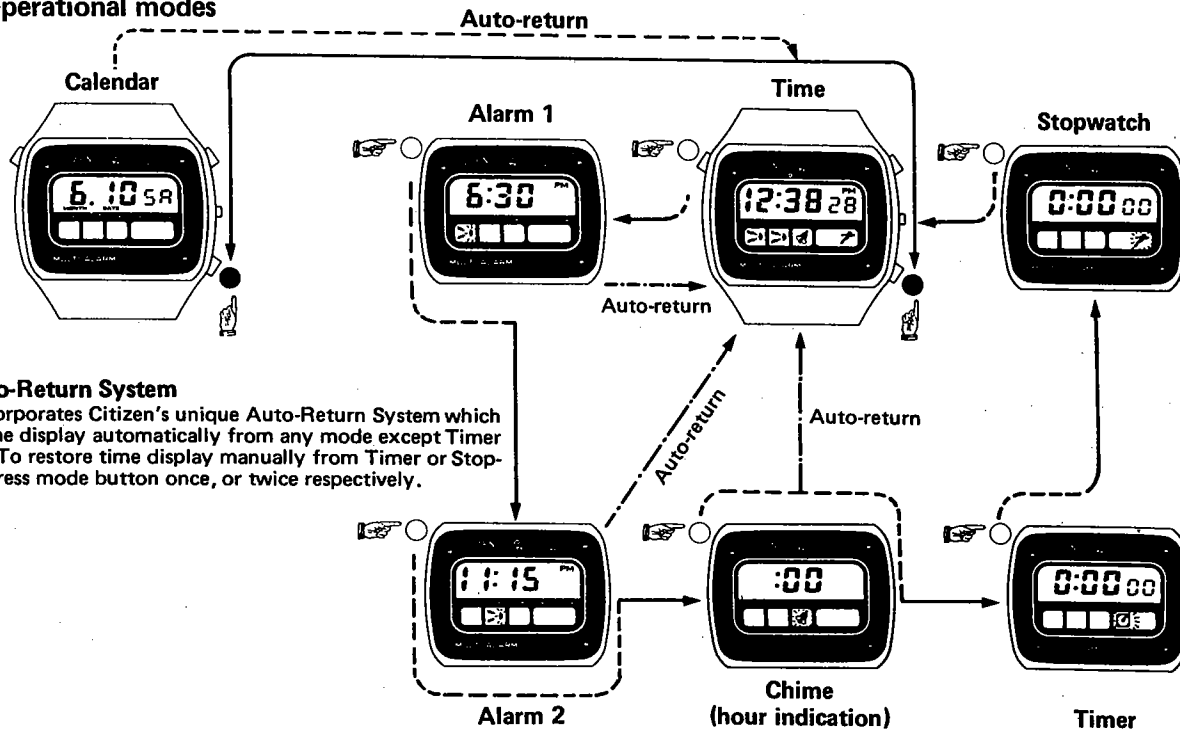

Citizen's Auto-Return System

This watch incorporates Citizen's unique Auto-Return System which restores the time display automatically from any mode except Timer or Stopwatch. To restore time display manually from Timer or Stopwatch mode, press mode button once, or twice respectively.

TIME

*The time reads here 12:38 P.M. plus 28 Seconds.

*Graphic indications represent only those modes set, or currently in operation.

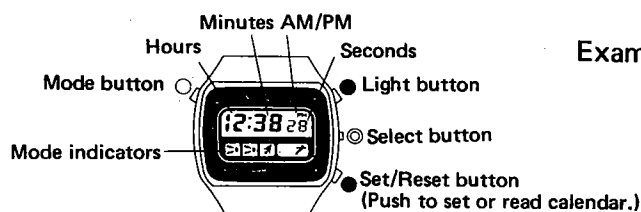

*Time is set in the order of seconds – minutes – hours (AM/PM).



CALENDAR

*The date reads June 10th (Saturday).

*No indications appear in the screens of the display panel when calendar is being read or set.

*Normal time display returns automatically to display panel within several minutes after reading or setting calendar, without pressing reset (black) button. Press reset button to restore time display instantaneously.

*The days of the week are indicated in English abbreviated as shown right.

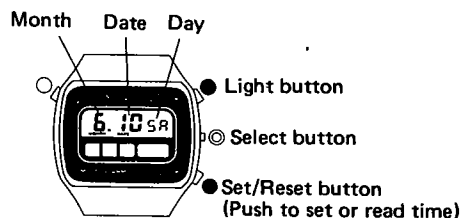

ALARM 1

Once set, Alarm 1 sound at the set hour and minute every day.

- *Alarm 1 is set for 6:30 P.M. (No other mode indications appears in the screens of the display panel while Alarm 1 is being set).
- *Alarm 1 & Alarm 2 allow setting of hours and minutes only, no seconds.
- *Set each alarm in the order of hours (AM/PM) and minutes.
- *Normal time display returns automatically to display panel within several seconds after setting.

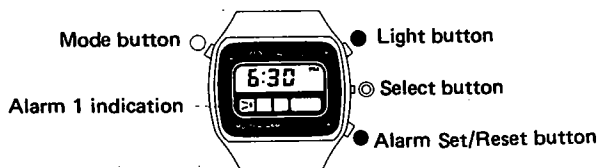

Alarm set to sound at present time.
 To suppress alarm, push reset (black) button; the flashing part of the graphic indication will leave the display panel (see below), and no alarm will sound when the specified time has been reached. To restore alarm, push reset (black) button a second time.
Alarm suppressed.

ALARM 2

Alarm 2 is a space alarm provided for added convenience.

- *Here Alarm 2 is set to sound at 11:15 P.M.
- *Other functions are same as Alarm 1.

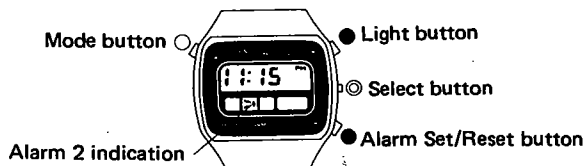

CHIME

The Chime feature provides a handy reminder of the time, every hour on the hour.

- *When Chime is set, two abrupt sound bursts will occur every hour on the hour. When hourly (e.g., no minutes) alarm settings have been made, the alarm will replace Chime which would normally sound at that time. Chime will sound as usual on the other hours.

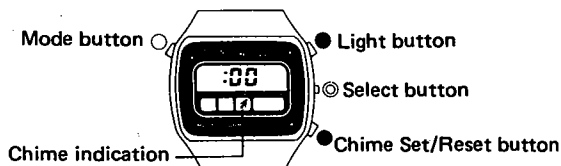

Chime set to sound every hour on the hour.
 When chime is not desired, push reset (black) button in chime mode. Suppressed Chime will be indicated by the absence of the striker portion of the bell on the chime status indication. No chime will sound once this setting has been made. To rest chime, push reset (black) button in Chime mode.
Chime suppressed.

TIMER

Count down. A timer that indicates the time still remaining. Set it for any time period . . . a beep that tells you when that period is up.

- *Timer can be set to time intervals up to 11 hours 59 minutes 59 seconds.
- *Countdown can be stopped or started as often as desired. Unless reset by pushing the Set/Reset (black) button, Timer count always resumes from point at which stopped.
- *Alarm will buzz sharply once when Timer is started; alarm will sound a full minute when Timer count reaches 0 hours 00 minutes 00 seconds.

Examples: 1:00 00 Alarm sounds when Timer is started with push of Start (yellow) button.

0:59 59

0:59 58

0:00 0:

0:00 00 ✓

Alarm sounds intermittently for one minute after time is up.

Timer setting is made in the order of hours → minutes → seconds.

Note: If setting was intended in timer mode, but indication flashes, and no numerals appear on the screen, the stopwatch mode is in operation. Make setting again according to the diagram, "Setting and Adjustment of Timer."

STOPWATCH

For speed races, car rallies, etc., a single alarm will sound when stopwatch is started or stopped.

- *Stopwatch can be used for the time intervals from 0 hours 00 minutes 00 seconds up to 11 hours 59 minutes 59 seconds.
- *A single alarm burst will sound when stopwatch is started or stopped.
- *Stopwatch indication returns instantly to 0:00 00 when reset (black) button is pressed.
- *Stopwatch can be stopped and started as often as desired. Stopwatch time display always resumes from point at which started unless reset by pushing the Set/Reset (black) button.

Note: If setting was intended in Stopwatch mode, but indication flashes and no numerals appear on the display panel, the Timer mode is in operation. Make setting again according to the diagram, "Setting and Adjustment of Stopwatch".

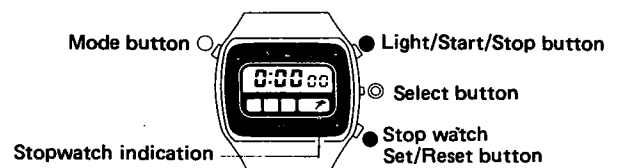
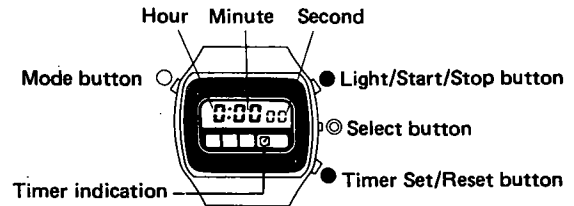

Alarm Monitor

When the timer mode and the calendar mode are on the display, the alarm will be heard if the Light (yellow) button and the Reset (black) button are pushed at the same time.

How to set time, calendar and each mode:
Adjustment and setting of time and date

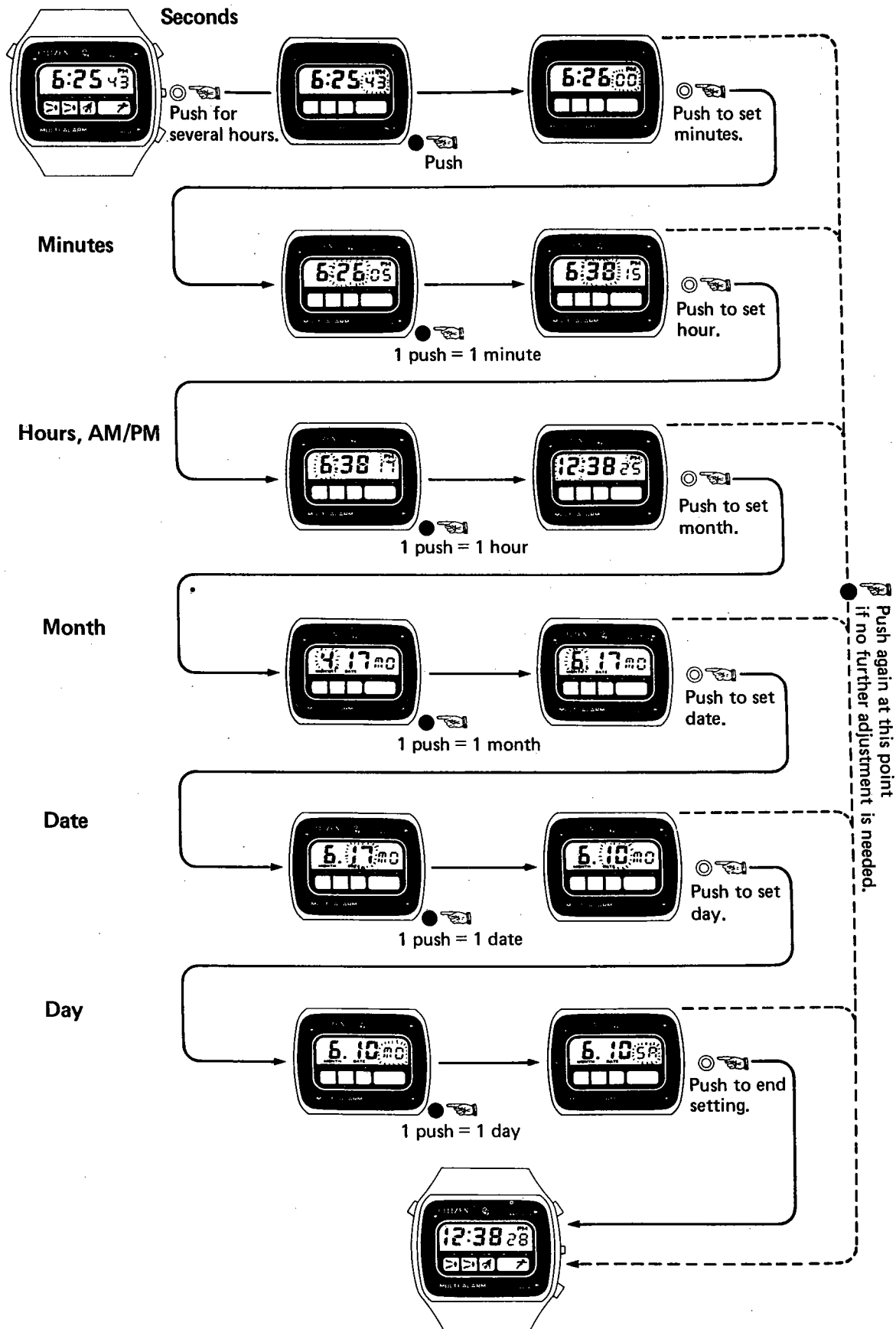

Setting and adjustment of alarms (common in Alarm 1 and 2)

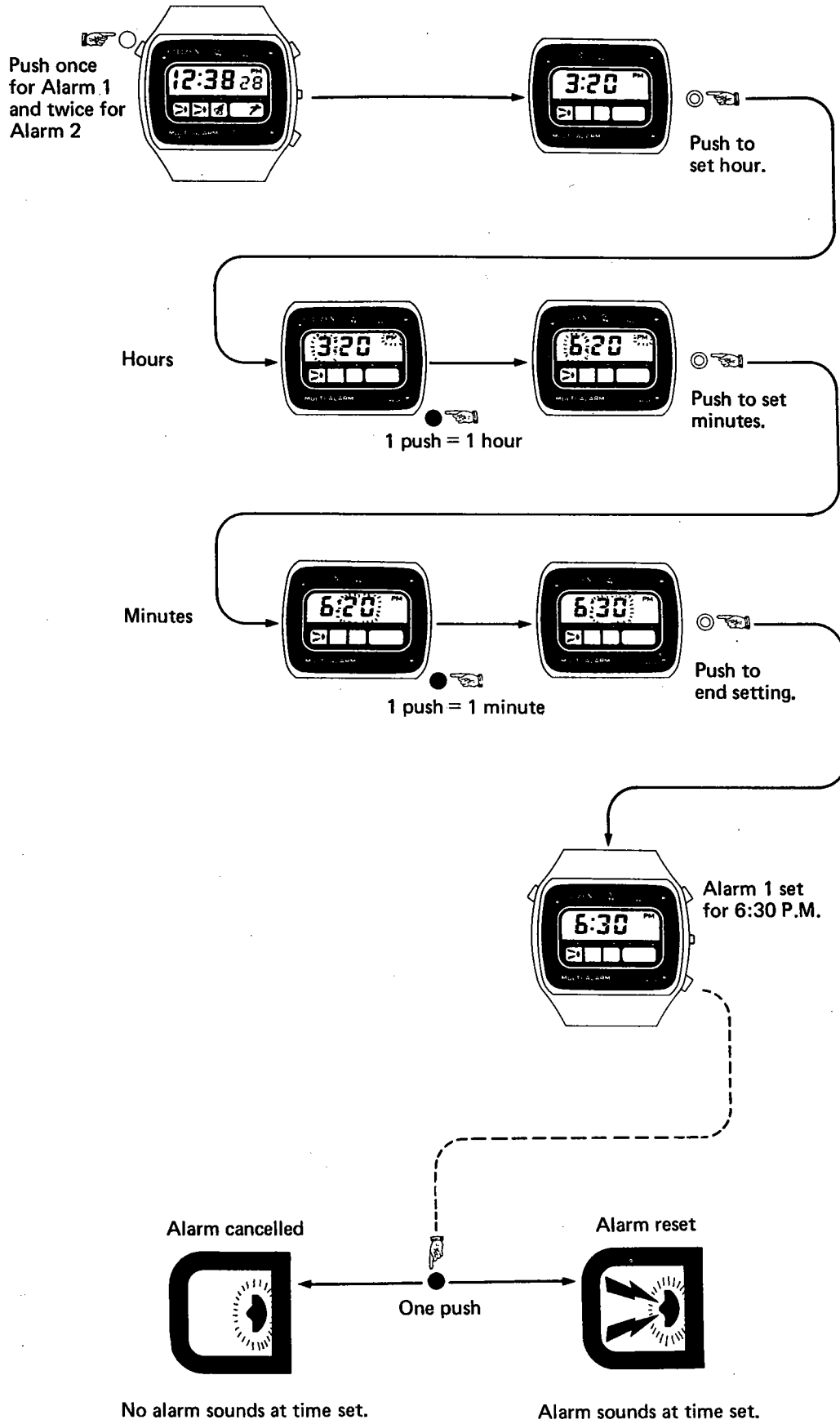

Setting of Chime

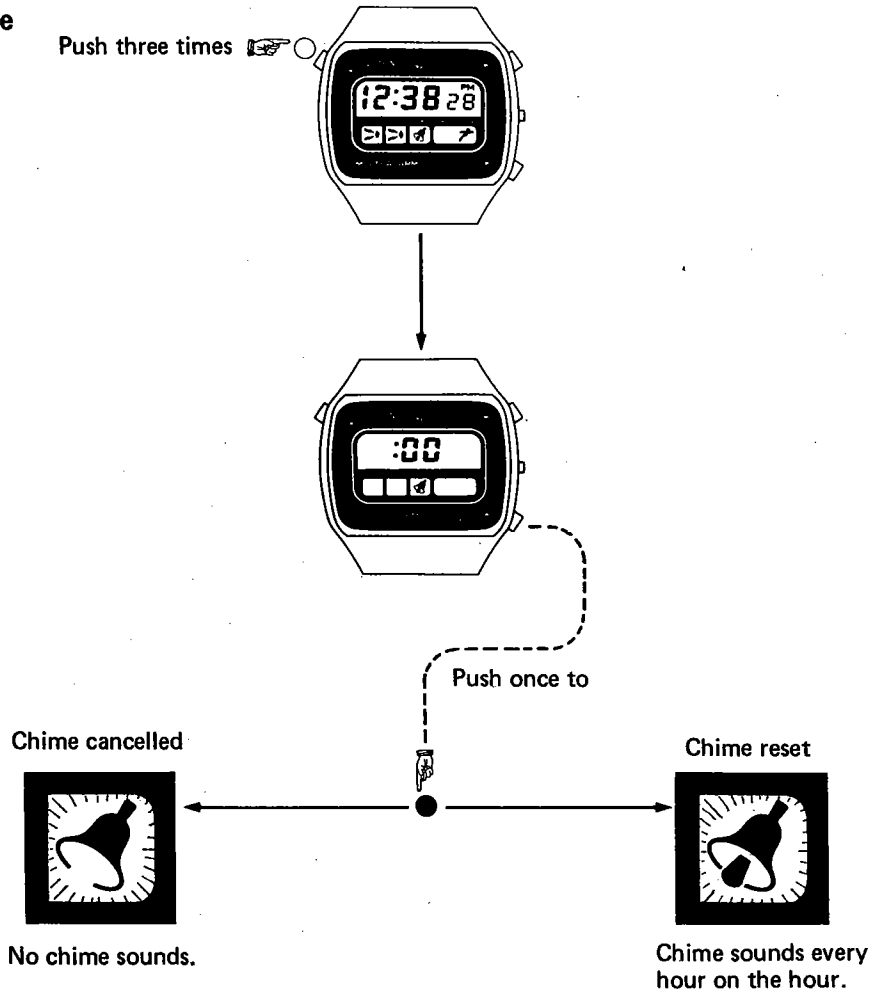

Use of timer

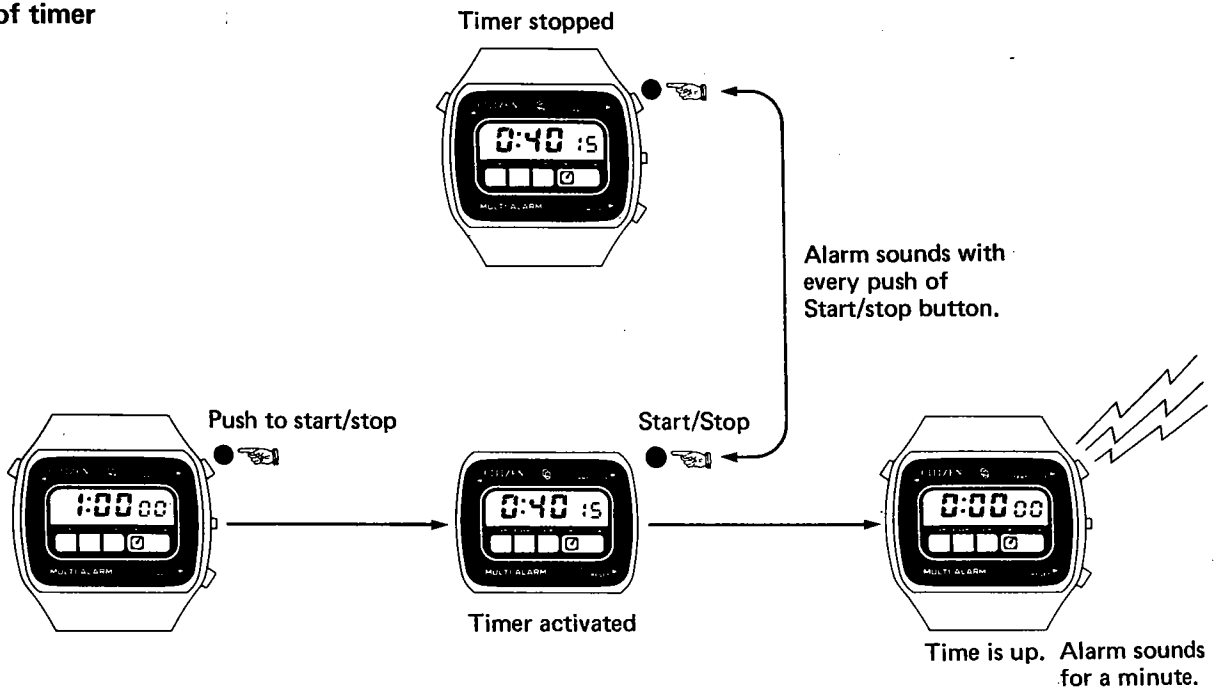

Setting and adjustment of stopwatch

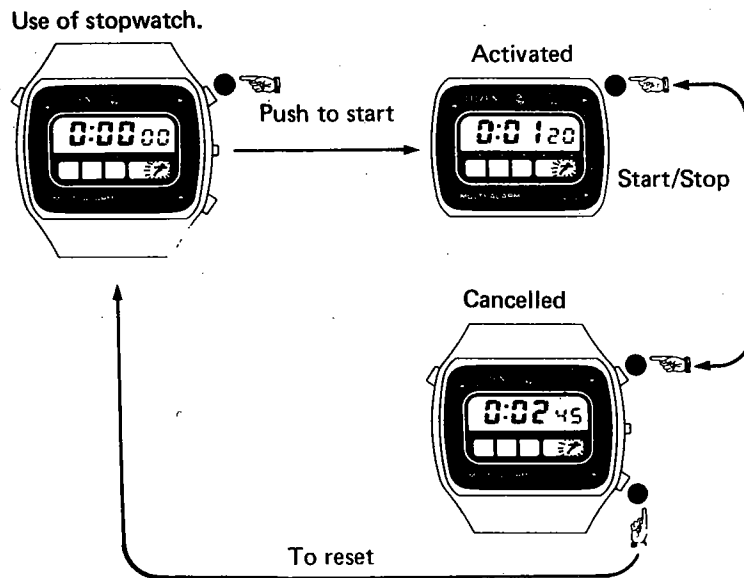
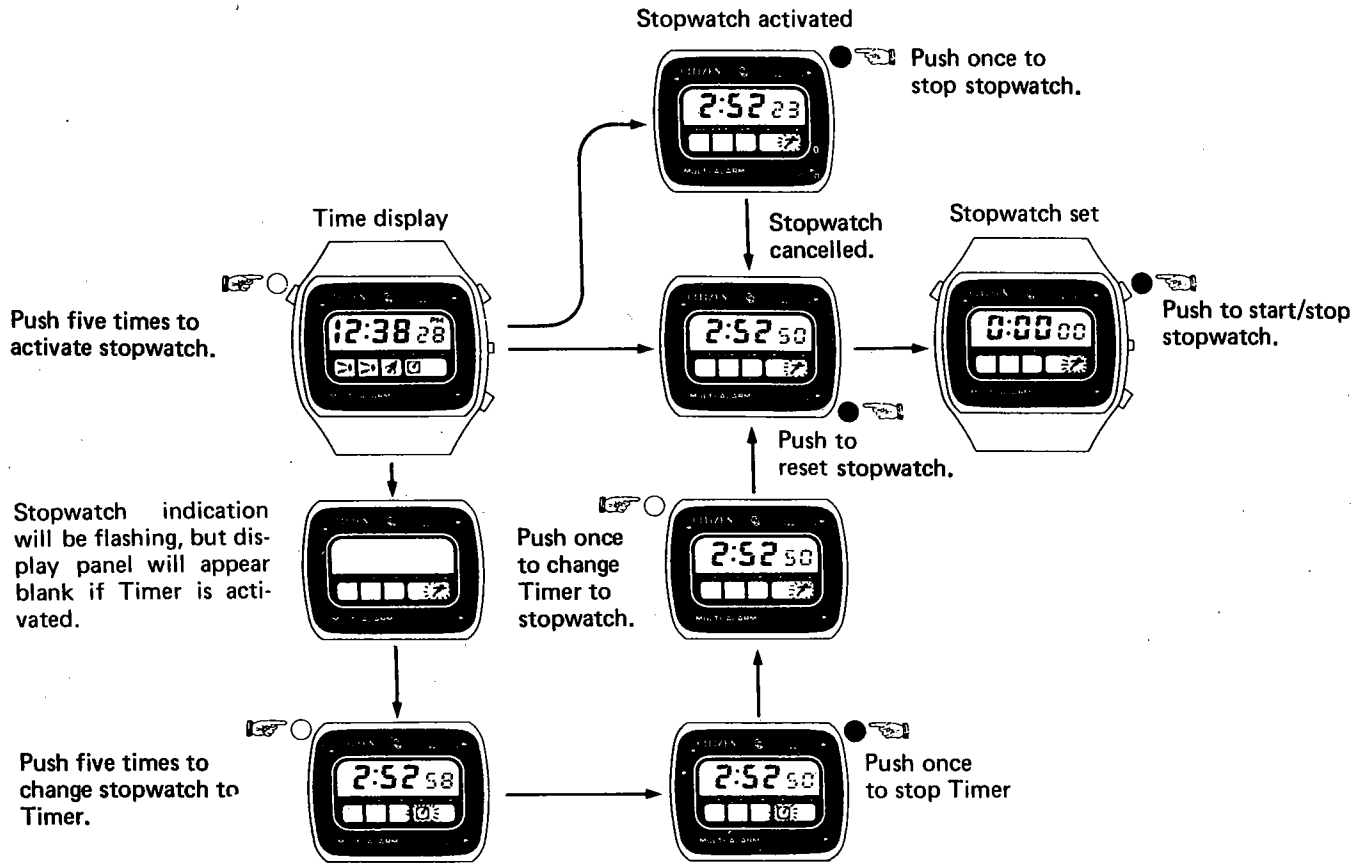

Cal. 9101A

1) Operational modes.

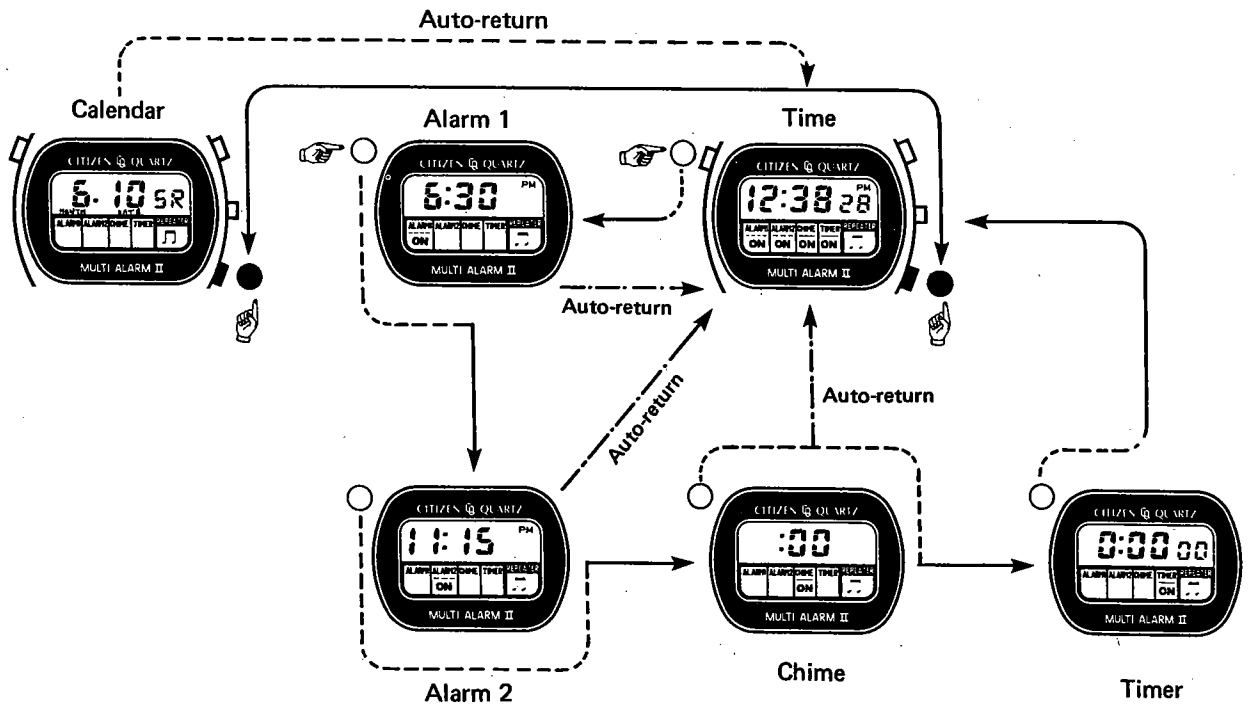

2) Setting and adjustment of time and calendar

The setting method is identical to Cal. No. 9100A with addition of the "year" setting after the "day" setting. The year can be set in a cycle of 1970~2009 years.

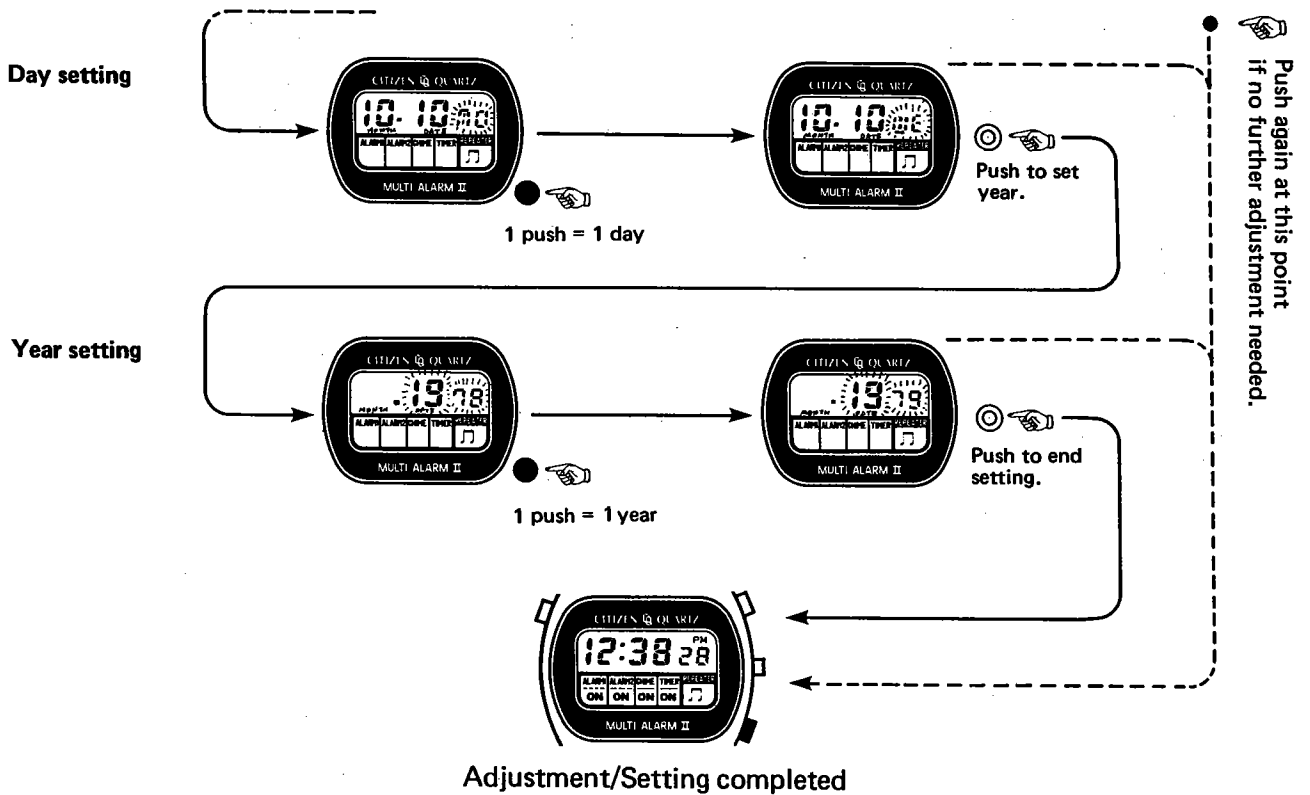

3) Setting and adjustment of Alarms (common in Alarm 1 and 2)

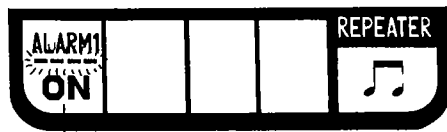

Alarm 1 set mark



Alarm 2 set mark

■ Alarm set/cancel

With every push of the black button in the alarm normal display mode, the alarm set and cancel are repeated alternately.

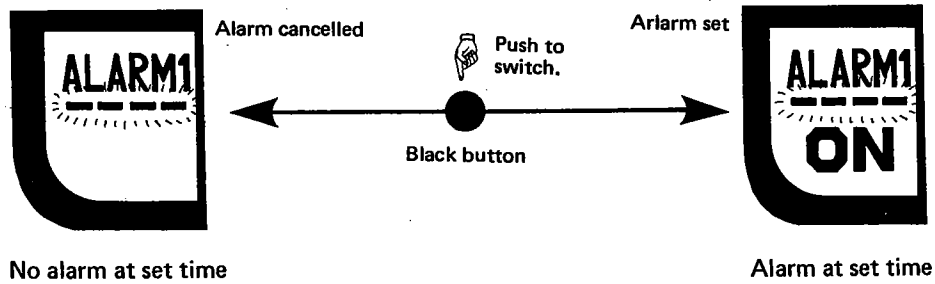

■ The setting procedure of the alarm time is identical to Cal. No. 9100A.

4) Setting of chime

With every push of the black button in the chime display mode, the chime set and cancel are repeated alternately.

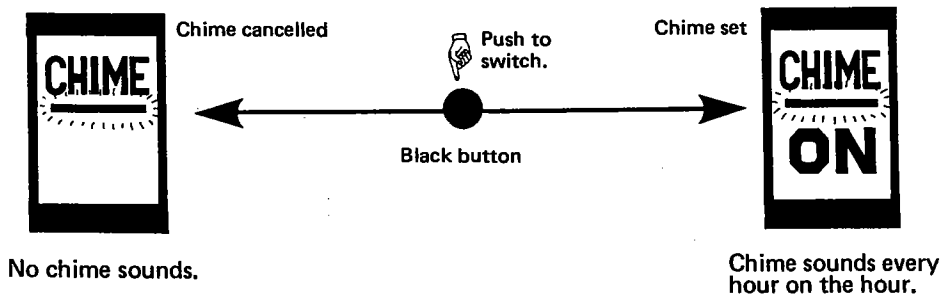

5) Setting and adjustment of timer

- The timer can be used independently for Cal. No. 9101A since no stopwatch is incorporated.
- The setting procedure of the timer is identical to Cal. No. 9100A.

6) Handling of time announcement device

With simultaneous push of  -button (yellow) and Set/Reset button (black) in the normal time display or the calendar display mode, the time is announced in three different ways of sounding at the instant of the button push.

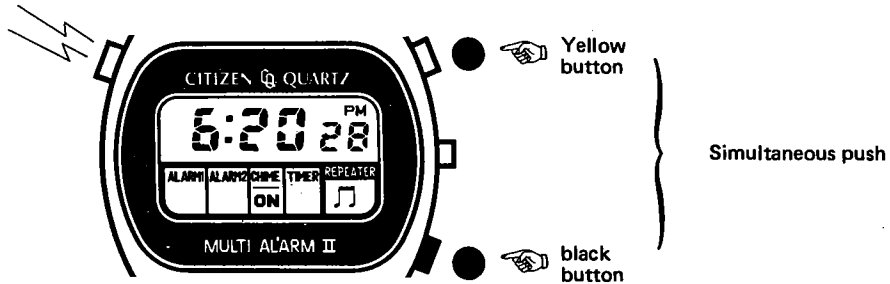

The three different ways of sounding varies in the "hour", "10-minute digit" and "1-minute digit" with no "second" sounding nor discrimination between AM and PM.

■ Sounding of hour

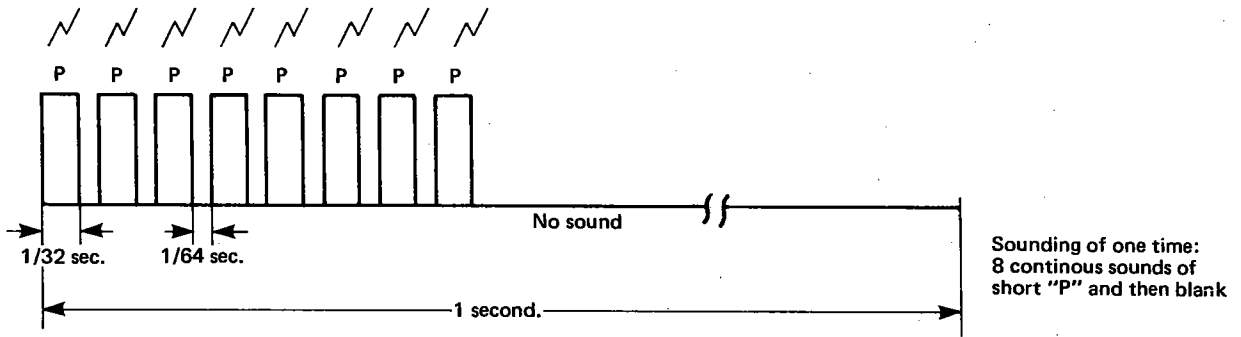

This way of sounding is repeated in the same frequencies as the number of the "hour" then, for example, 5 times for "5 o'clock".

■ Sounding of 10-minute digit

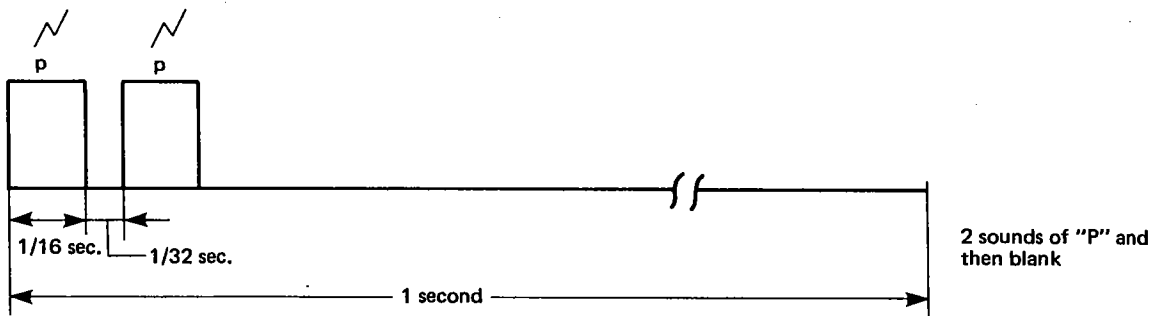

This sounding is given in the same frequencies as the number of the 10-minute digit, for example, 4 times for "X-hour 4Y-minute".

■ Sounding of 1-minute digit

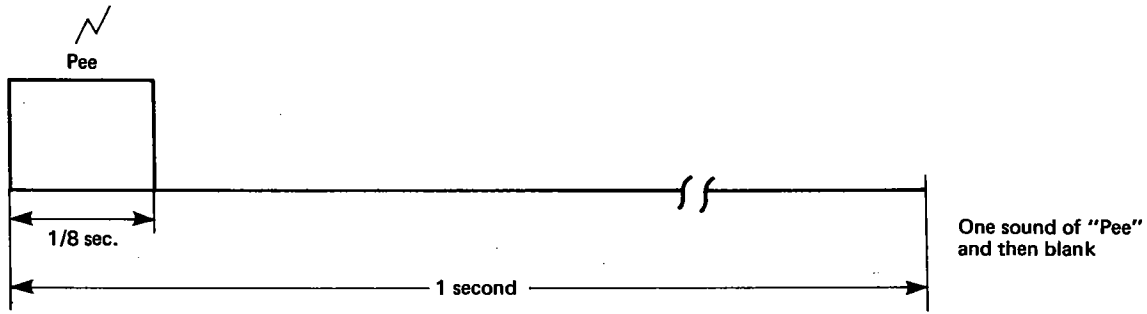

This sounding is given in the same frequencies as the number of the 1-minute digit, for example, 3 times for "X-hour X3-minute".

Thus, the "hour" is announced with 1-second blank followed; the "10-minute digit" is announced with 1-second blank followed; and finally the "1-minute digit" is announced.

(Ex.) With simultaneous push of both the yellow and black buttons when the time shows "5:26", 5 times of hour sounding with 1-second blank followed, 2 times of 10-minute digit sounding with 1-second blank and 6 times of 1-minute digit sounding are given respectively.

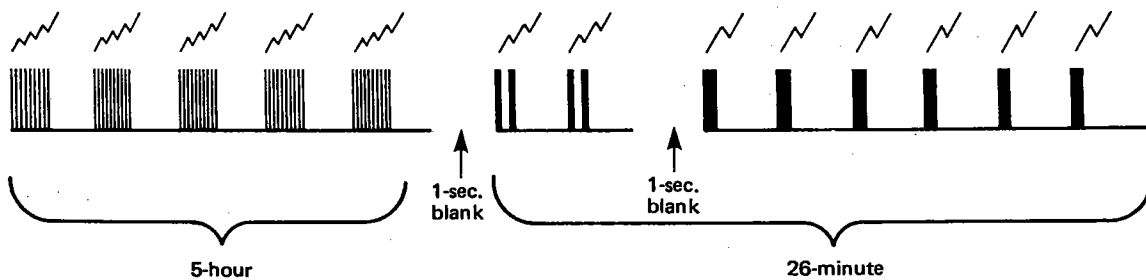

*In case the 10-minute digit or the 1-minute digit is "0", these digits has no sounding.

Examples:

10:00 10 times of hour sounding

8:05 8 times of hour sounding with 1-second blank followed and 5 times of 1-minute digit sound

7:40 7 times of hour sounding with 1-second blank followed and then 4 times of 10-digit sounding

§4. SPECIFICATIONS

Model		Citizen Quartz Multi Alarm
Cal. No.		9100A 9101A
Movement	Diameter	27.2mm ϕ
	Thickness	6.06mm
Oscillation		32,768Hz
Accuracy		± 10 sec./month under normal temperature
Display information	Normal display	"Hour", "minute", "second" and "AM/PM"
	Calendar display	"Month", "date" and "day" (year at setting time with Cal. 9101A)
	Alarm display	"Hour" and "minute"
	Chime display	" : 00 "
	Timer display	"Hour", "minute" and "second" Set time: 11 h. 59 min. 59 sec.
	Stopwatch display	Measurement range: 0 sec. – 11 h. 59 min. (Cal. 9100A) 59 sec. Cumulative count possible
Display system		FE twist-type nematic LC display
Effective temperature range		0°C (32°F) ~ +60°C (140°F)
Semiconductor		C/MOS-LSI
Additional mechanisms		Alarm-1, Alarm-2 Chime Timer Stopwatch (Cal: 9100A) Alarm monitor Time announcement (Cal. 9101A) Illumination lamp Power cell life indicator Automatic calendar setting
Power cell		Small-size silver oxide power cell Parts No. 280-15 (1 unit) Nominal Voltage : 1.55V Capacity : 75mAH Size : 11.56mm ϕ X 3.0mm Life : about 2 years

§5. DISASSEMBLY AND ASSEMBLY PROCEDURE OF MOVEMENT

Disassembling procedure ① → ⑬
 Assembling procedure ⑬ → ①
 The number of screws necessary for parts is shown by the symbol like (2).

■ Notes:

1. Assembling procedure

- Assemble the power cell, power cell strap, power cell side after completion of assembly of LC display panel side.
- Set in the power cell with the plus (+) side up.

2. Power cell connector

Before setting power cell, make sure that the power cell connector and space for power cell connector are correctly positioned as well as that the contact pressure of the power cell holder spring is enough secured.

Avoid washing the electronic parts. Remove dusts or stains on the contact sections since they may deteriorate good conductivity. Lubrication to the movement is unnecessary.

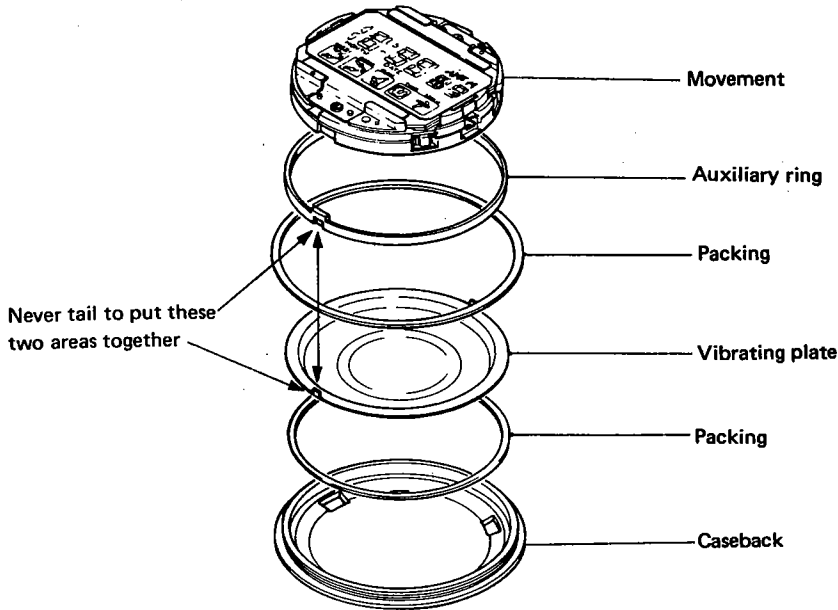
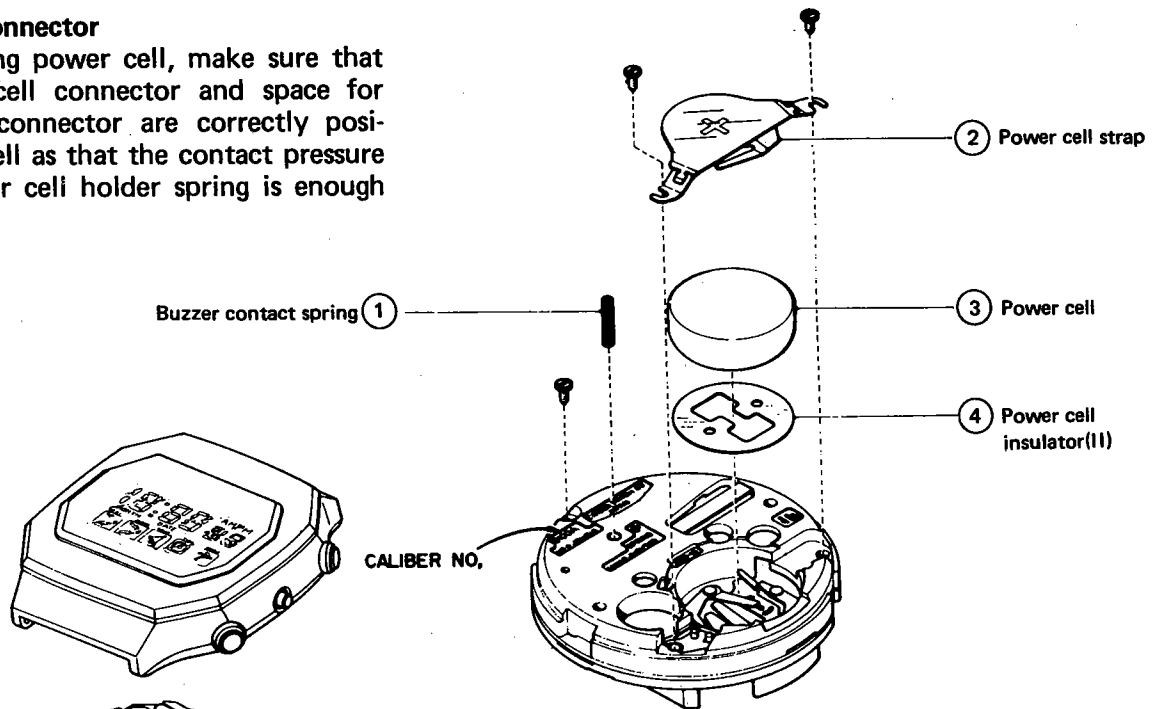

Caution for Watchcase Attachement:
 The auxiliary ring is attached to the prescribed position on the caseback after incorporation of the buzzer contact spring. (The play part of the auxiliary ring is fitted to the two protrusion parts of the vibrating plate.) Then, the protrusion part of the auxiliary ring is fitted to the play part of the movement to put and tighten the caseback. If the vibrating plate has a gap against the movement, no alarm sound is produced.

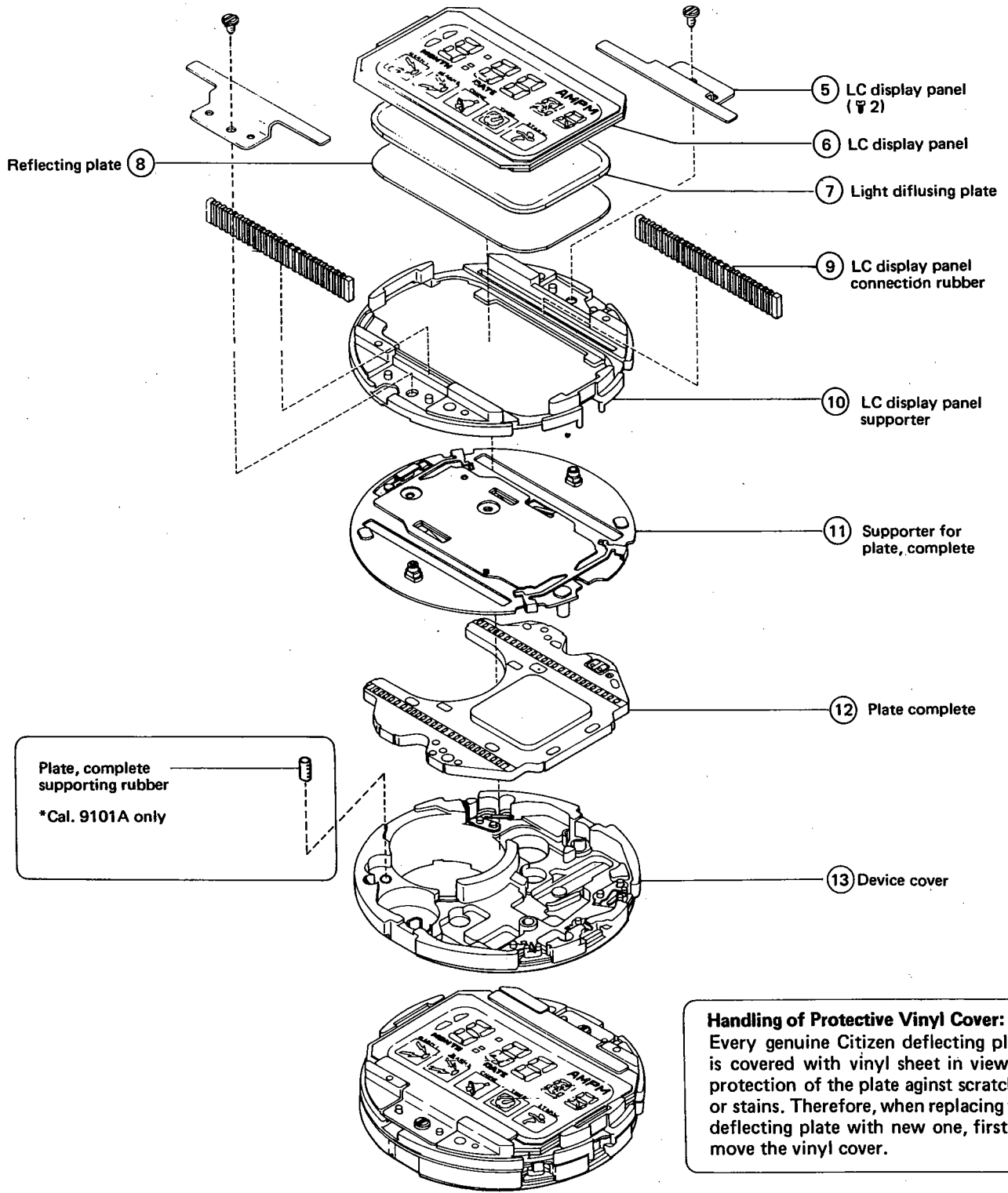

Handling of Protective Vinyl Cover:
Every genuine Citizen deflecting plate is covered with vinyl sheet in view of protection of the plate against scratches or stains. Therefore, when replacing the deflecting plate with new one, first remove the vinyl cover.

§6. TROUBLESHOOTING

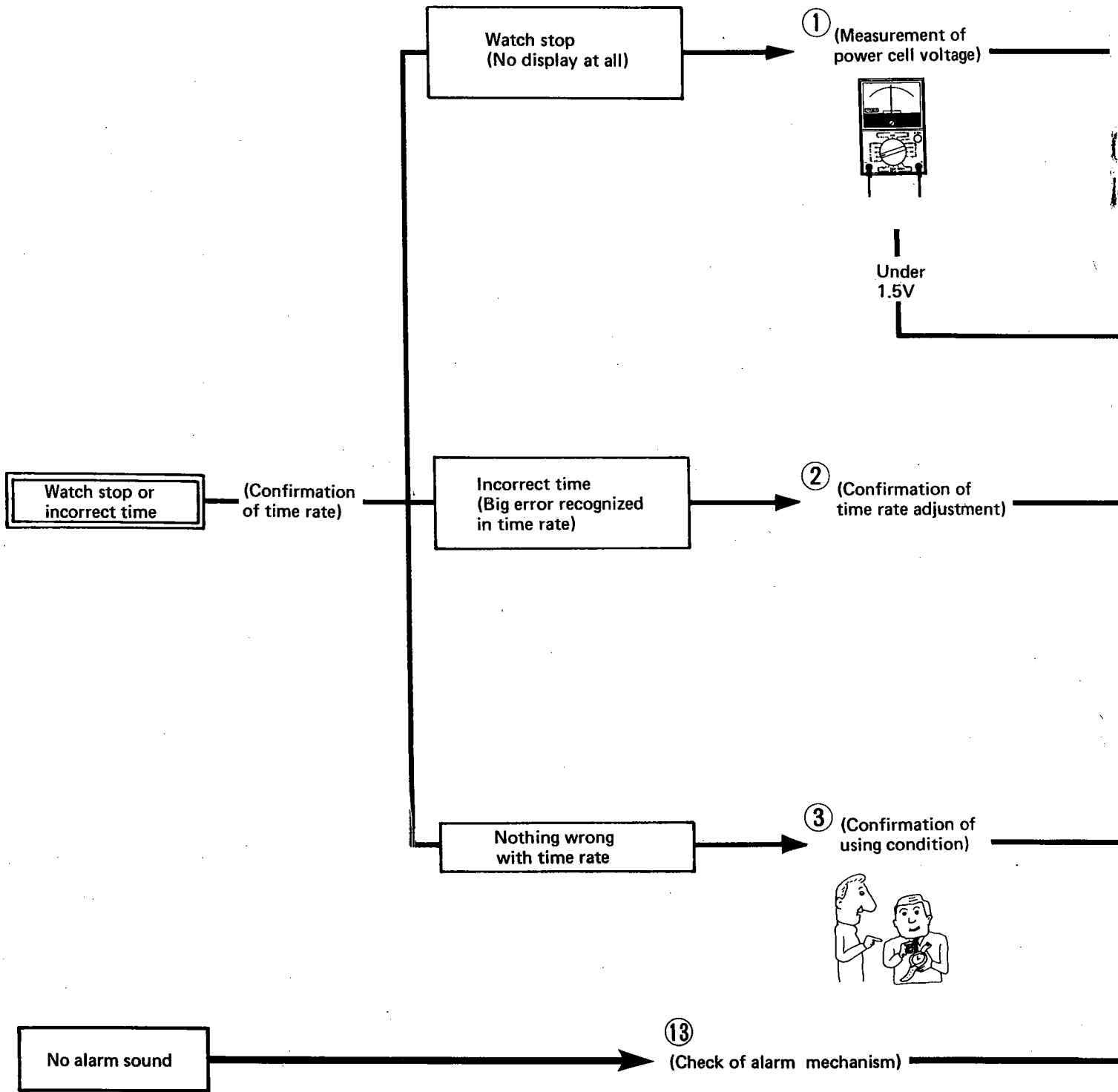

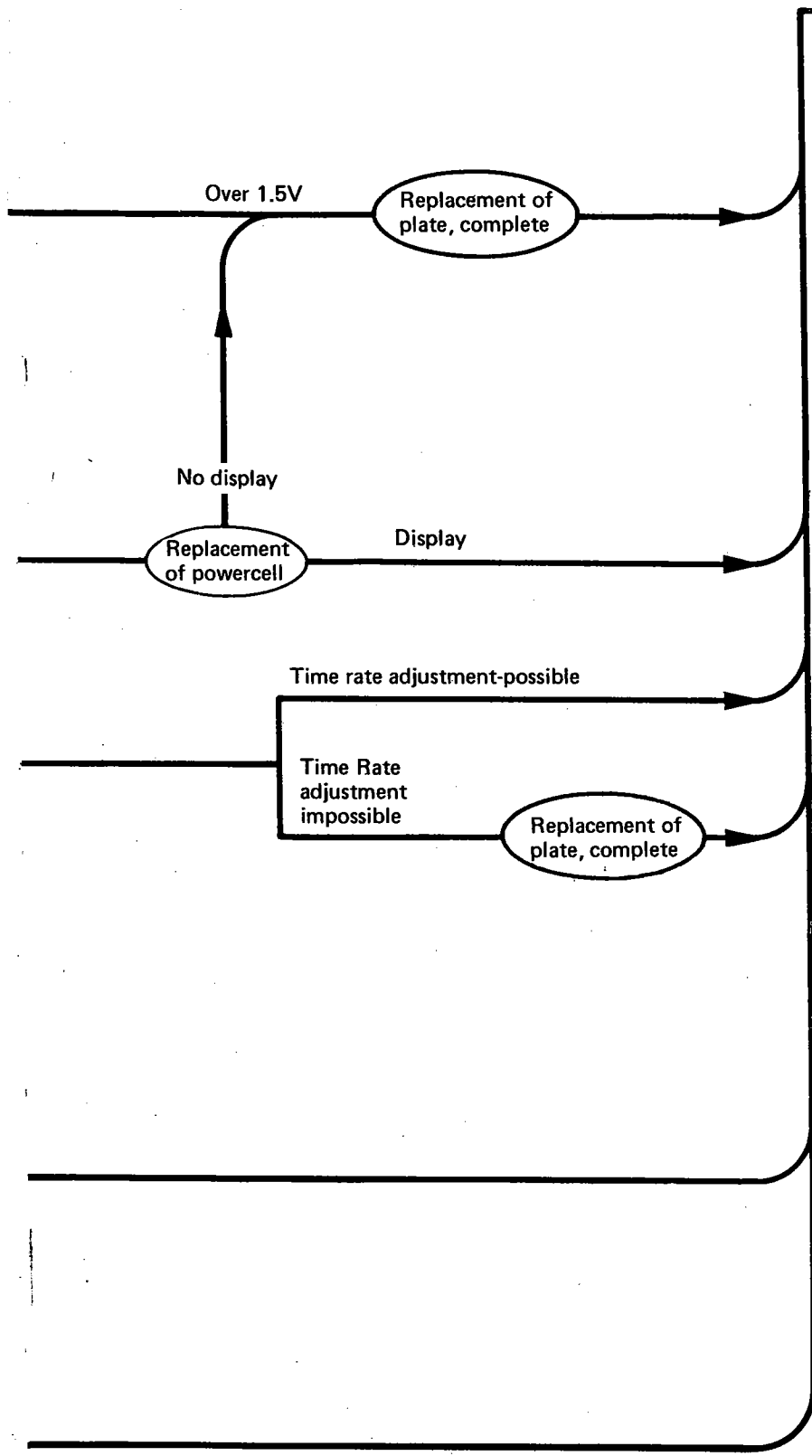

Common checking items

⑭ (Measurement of power cell voltage)

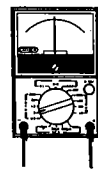

⑮ (Measurement of power consumption)

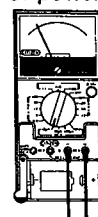

⑯ (Time adjustment)

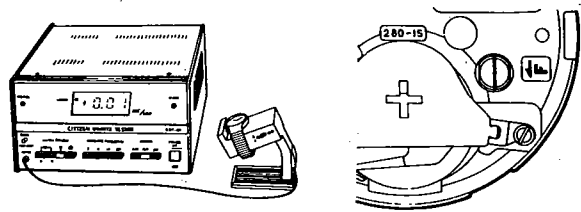

⑰ (Check of appearance function)



Completion

Incomplete functioning of display and related mechanisms

Segment partially invisible

④ (Check of display panel connection section)



Display switching (normal ⇌ calendar) impossible

⑤ Check of display switching (normal ⇌ calendar) mechanism

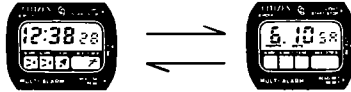

Mode switching (normal ⇌ alarm-I, alarm-II, chime, timer, stop watch) impossible

⑥ Check of mode switching (normal ⇌ alarm-I, alarm-II, chime, timer, stop watch) mechanism



Incomplete functioning of additional mechanisms



Correction, digit selection impossible for time/calendar

⑦ Check of correction, digit selection mechanism of time/calendar

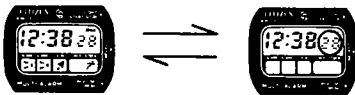

Correction, digit selection impossible for alarm, timer

⑧ Check of correction, digit selection mechanism of alarm, timer

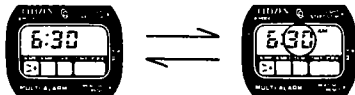

On/off impossible for chime or no operation of stop watch, 0-reset

⑨ Check of time signal on/off, stop watch, 0-reset mechanism



No lamp illumination or no operation of start/stop for timer, stop watch

⑩ Check of lamp illumination mechanism (timer, stop watch start/stop)



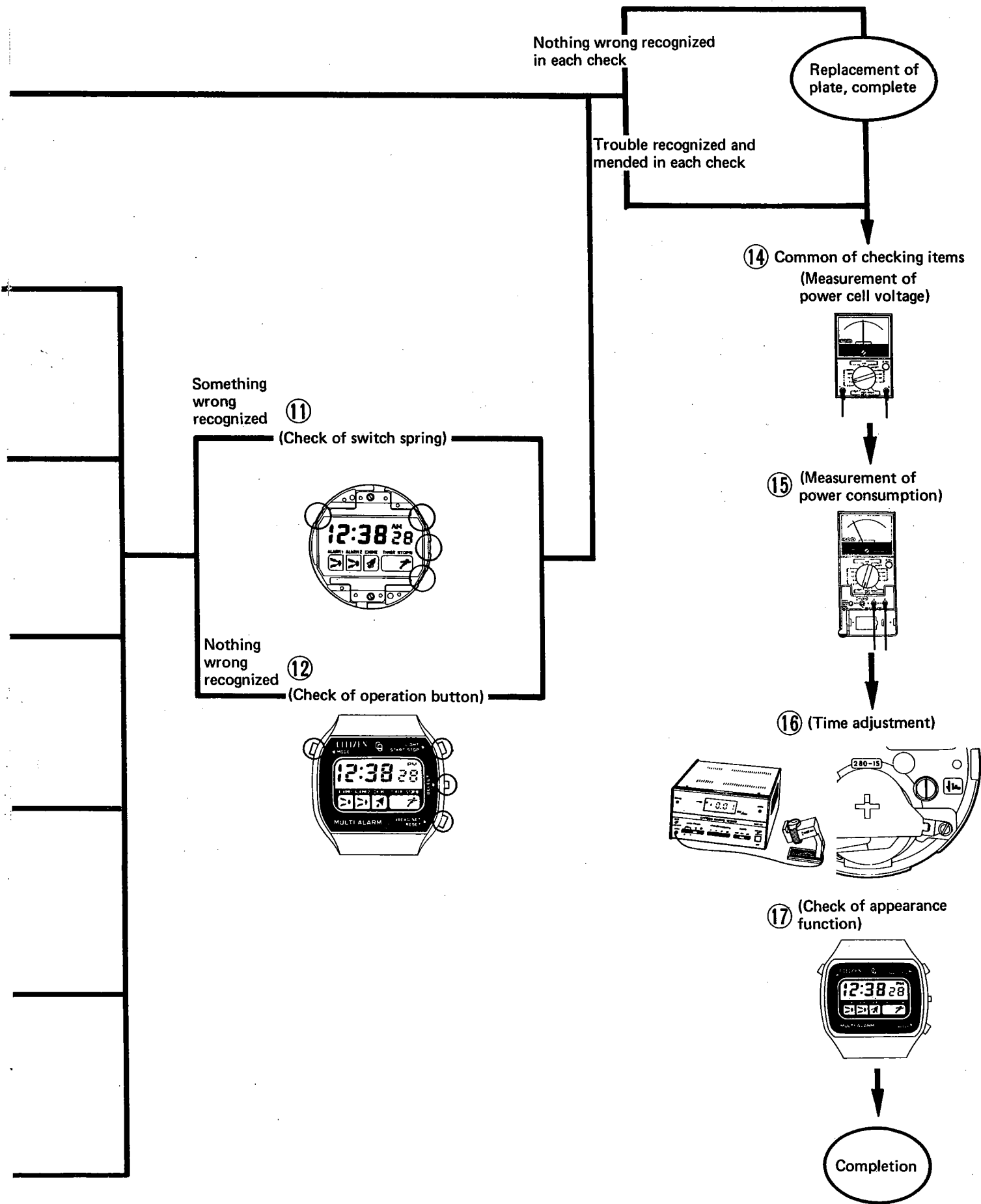

Watch stop -- No display at all

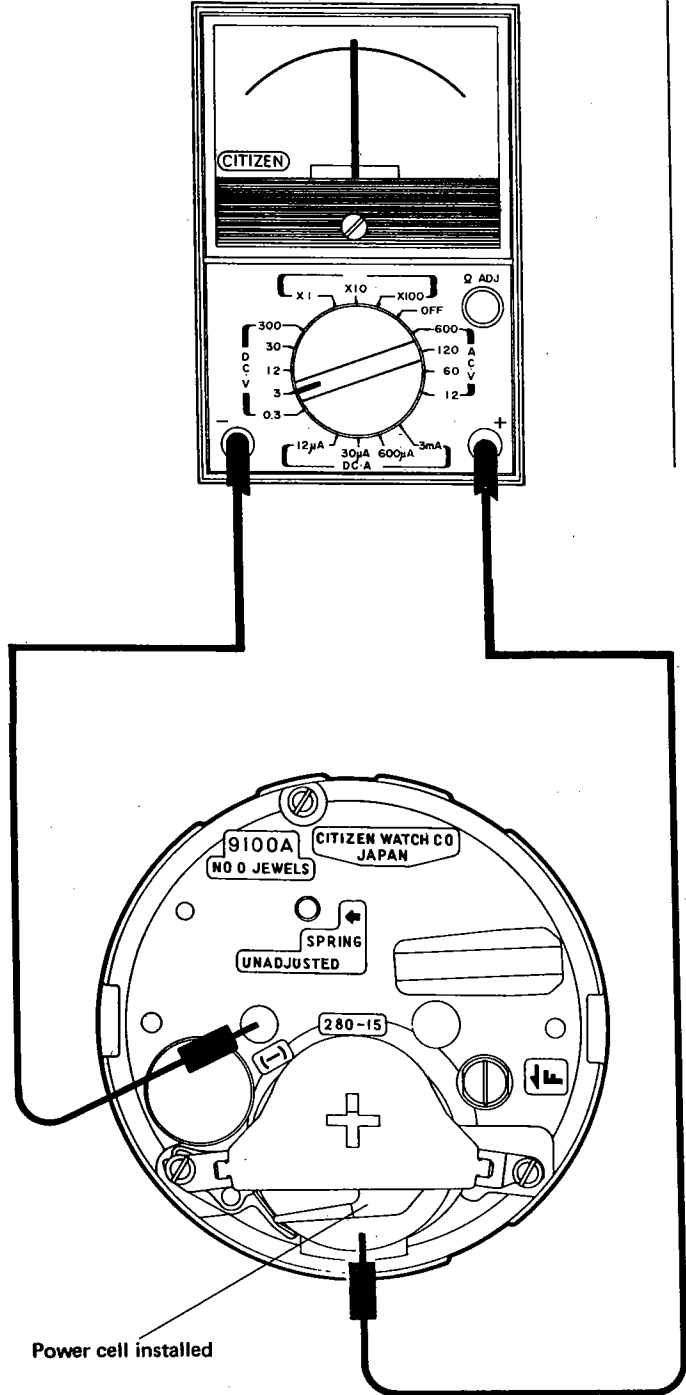
Check items	How to check	Results	Treatment
<p>1 Measurement of power cell voltage</p>	<div data-bbox="357 367 803 430" style="border: 1px solid black; padding: 5px; text-align: center;"> <p>Power cell voltage: Over 1.5V</p> </div> 	<div data-bbox="933 367 1404 808" style="border: 1px solid black; padding: 10px;"> <p style="text-align: center;">Results and Treatment</p> <p>Over 1.5V</p> <ul style="list-style-type: none"> • No display of LC display panel → Replace plate, complete. <p>Under 1.5V</p> <p>Replace power cell,</p> <ul style="list-style-type: none"> • Correct display of LC display panel → ⑮ Measurement of power consumption • No display of LC display panel → Replace plate, complete. </div>	<div data-bbox="982 1134 1421 1596" style="border: 1px solid black; padding: 10px;"> <p style="text-align: center;">Note</p> <p>(1) If the watch has been used more than two years, replace the power cell with the new one even if it shows more than 1.5V output power.</p> <p>(2) In case the reading shows over 1.5V due to unstable voltage or OV in the measurement of a single-unit power cell through the measurement method shown left, the minus (-) side of the power cell may not sometimes touch completely the power cell connection spring. So that both the shape and position of the spring must be well examined.</p> </div>

Big error recognized in time rate

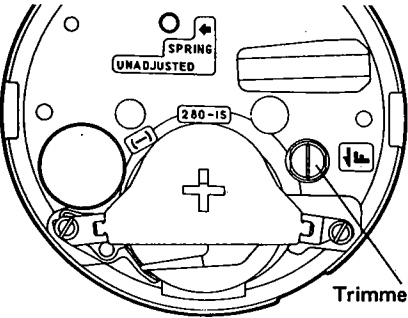
Check items	How to check	Results	Treatment
<p>2 Confirmation of time rate adjustment</p>	<p>As the case for incorrect time (big error), it is considered that the quartz crystal oscillator attached to the plate has a big error in its frequency. Conduct check by the following procedure.</p> <p>(1) Check whether the trimmer condenser is capable to adjust the time or not.</p>  <p>(2) In case the trimmer condenser can perform time adjustment:</p> <p>(3) In case the trimmer condenser is unable to adjust time, it is considered that the quartz crystal oscillator is faulty.</p> <p>Check points When a big amount of gains is recognized in the time rate measurement or there is no difference at all in the time rate even if the trimmer condenser is turned right and left, it is considered that the dielectric substance used for trimmer condenser has some cracks. In such a case, replace the plate, complete.</p>		<p>⑭ Measurement of power cell voltage.</p> <p>→ Replace plate, complete.</p>

Nothing wrong recognized in time rate

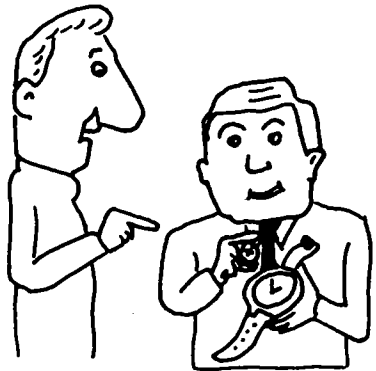
Check items	How to check	Results	Treatment
<p>3 Confirmation of using condition</p>	<p>Check how the customer has been using the watch. Ex. Aren't there any mistakes in handling the watch? And other factors.</p> 		

Incomplete functioning of display mechanism – Segment partial invisible

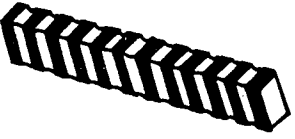
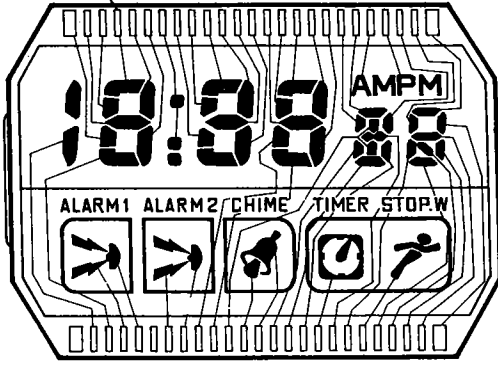
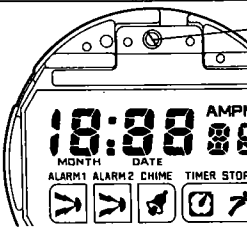
Check items	How to check	Results	Treatment
<p>4 Check of LC display panel connection section</p>	<p>For the cause of segment partial invisible, two factors are conceivable: the contact is unstable between the LC display panel and the electronic circuit; and the electronic circuit has some defects. However, the former may be more defects. However, the former may be more defects, so that conduct check placing major emphasis on the contact sections.</p> <ol style="list-style-type: none"> 1. Check the screws for LC display panel holder and related condition. <ol style="list-style-type: none"> (1) Aren't there any broken screws? (2) Aren't there any loosened screws? (3) Is the LC display panel holder holding the LC display panel evenly? 2. Check the LC display panel connection rubber for electrical contact. <ol style="list-style-type: none"> (1) Isn't it twisted? (2) Isn't the rubber worn out or extremely stretched out? (3) Aren't dusts or stain attached on the rubber?  <p>LC display panel connection rubber</p> <ol style="list-style-type: none"> 3. Referring the illustration below, check the LC display panel's electrode sections of segment invisible whether or not there are any dust or stains.  <p>Electrod section</p>	 <p>Screw for LC display panel holder</p> <p>Screws broken</p> <p>Screws loosened</p> <p>LC display panel held unevenly</p> <p>Rubber twisted</p> <p>Rubber worn out</p> <p>Dusts or stains attached</p> <p>Dust or stains attached</p> <p>Nothing wrong perceived</p>	<p>Replace broken screws and fasten them tight.</p> <p>Tighten them again</p> <p>Refix it</p> <p>Replace the rubber</p> <p>Replace the rubber</p> <p>Remove them</p> <p>Remove them</p> <p>Replace LC display panel, even after which trouble is not solved. → Replace plate, complete</p>

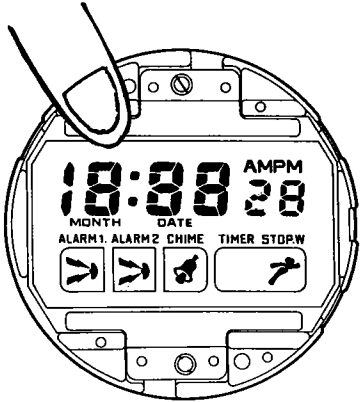
Check item	How to check	Results	Treatment
	<p>Check points One quick way to check the segment partial invisible is to push softly around the segment-broken area as shown in the picture below. In this instance, if the broken segment is displayed again, it is clear that the trouble is in unstable contact. In such a case, replace the LC display panel connection rubber for electrical contact.</p> 	<p>Note: Be careful not to push the LC display panel too strongly since it will break the glass.</p>	

Incomplete functioning of additional mechanisms – Display switching (Normal ⇌ Calendar) impossible

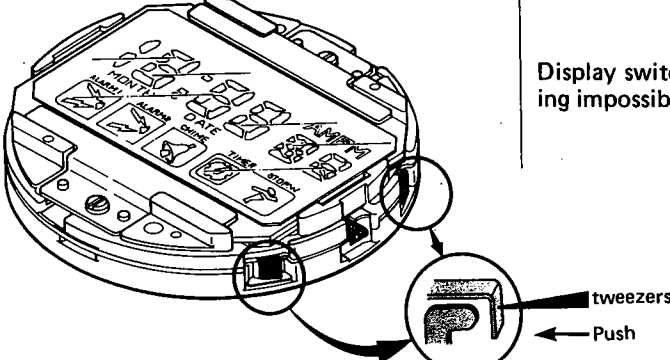
Check items	How to check	Results	Treatment
<p>5 Check of display switching mechanism (normal ⇌ calendar)</p>	<p>As for the casue of display switch incapability from normal display of "hour", "minute", "second", "day" and "AM/PM" to "year", "month", "date" and "day" calendar display of the electrical factor (some troubles in the electronic circuit) or mechanical factors (incomplete contact, deformation of parts, etc.) may be considered. Therefore, conduct a check by the following procedure.</p> <p>Take out the movement from the watchcase.</p> <p>As illustrated below, have an electrical conduction between the switch spring and LC display panel holder by means of a metal tweezers. At this moment, check whether the normal display can correctly be changed to "year", "month", "date" and "day" indication.</p> 	<p>Display switching possible</p> <p>Display switching impossible</p>	<p>No trouble with electrical factor → ⑫ Check of operation button</p> <p>⑪ Check of switch spring</p>

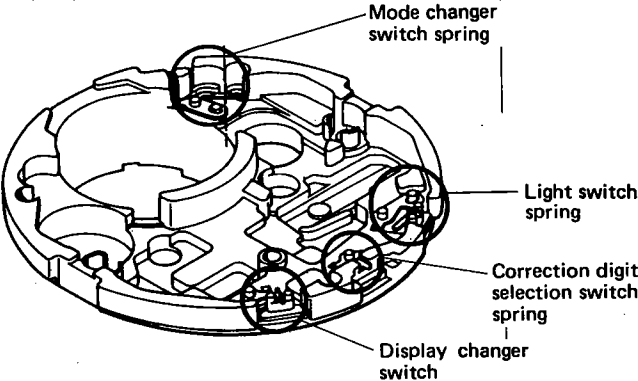
Check items	How to check	Results	Treatment
	<p>1. Check whether the change-over switch spring is attached completely to the device cover.</p> <p>2. Check whether the change-over switch spring has any breakage or curvature.</p>  <p>3. Remove the push-button and check whether it has any breakage, curvature or dust and stains attached.</p>	<p>Breakage or curvature</p> <p>Dust or stains</p>	<p>Replacement of push-button</p> <p>Removal</p>

Mode switching impossible

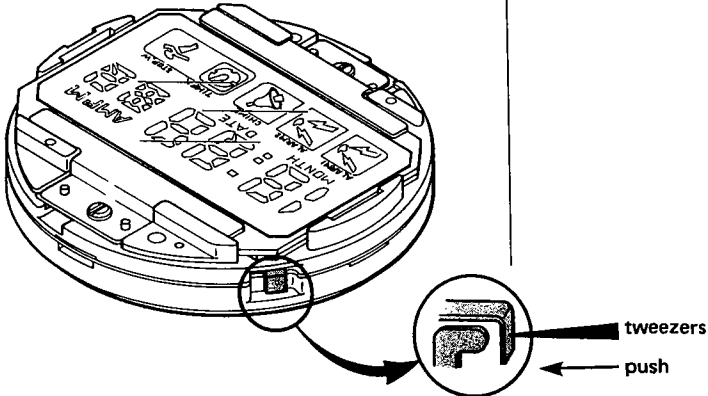
Check items	How to check	Results	Treatment
<p>6 Check of mode switching mechanism (normal/calendar display Alarm 1 and 2, chime signal, reverse operation timer, stop watch)</p>	<p>The mode switching is impossible between normal display ("hour", "minute", "second" and "AM/PM") and alarm 1 and 2, chime, reverse operation timer plus stop watch. Two causes are presumed for the above trouble: the electrical defect (troubles in electronic circuits) and the mechanical defect (unstable contact, parts deformation, etc.).</p> <p>Have a check for the mode switching switch spring and its related mechanism referring to 5 (check of display switching mechanism).</p> 		

Time/calendar digit selection impossible

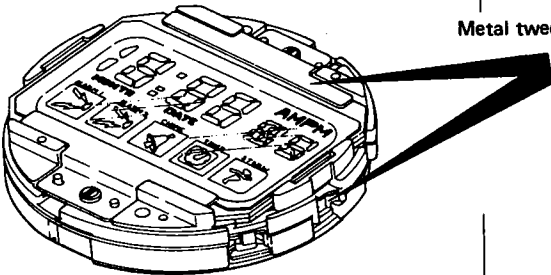
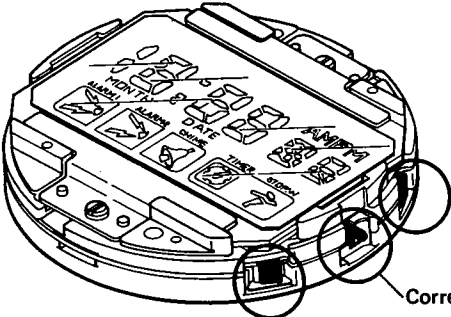
Check items	How to check	Results	Treatment
<p>7 Check of time/calendar digit selection mechanism</p>	<p>The digit selection is impossible for "hour", "minute", "second", "month", "date" and "day". Two causes are presumed for the above trouble: the electrical defect (faulty electronic parts, etc.) and the mechanical defect (incomplete contact or parts breakage).</p> <p>As shown in the figure below, give a conduction between the correction digit selection switch spring and LC display panel holder using a Metal tweezers.</p>  <p>•A conduction of over two seconds is given only when "second" is selected.</p> 	<p>Digit selection possible →</p> <p>Digit selection impossible →</p>	<p>No electrical defect and ⑫ check of operation button</p> <p>⑪ Check of switch spring</p>

Correction digit selection impossible for alarm and reverse operation timer

Check items	How to check	Results	Treatment
<p>8 Check of digit selection mechanism for Alarm 1 and 2, reverse operation timer</p>	<p>The digit selection is impossible for "hour" and "minute" of alarm 1 and 2 plus "hour", "minute" and "second" of reverse operation timer.</p> <p>Two causes are presumed for the above trouble: the electrical defect (faulty electronic parts, etc.) and the mechanical defect (incomplete contact or parts breakage).</p> <p>Have a check for the correction digit selection switch spring referring to 5 (Check of display switching mechanism).</p> <div data-bbox="462 714 844 997" data-label="Image"> </div> <p data-bbox="641 1039 876 1081">Correction digit selection switch spring</p>		

Chime ON/OFF and stop watch 0-resetting impossible

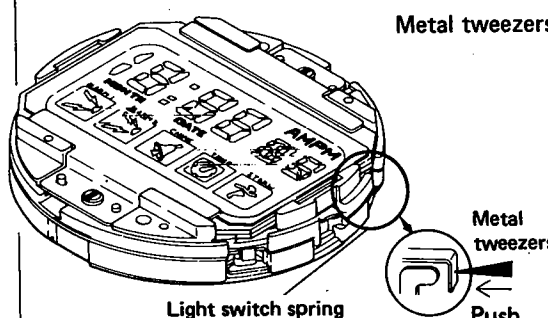
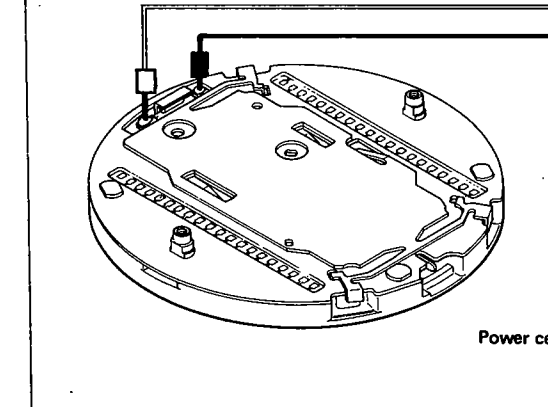

Check items	How to check	Results	Treatment
<p>9 Check of chime ON/OFF and stop watch 0-resetting mechanism</p>	<p>The chime ON/OFF and stop watch 0-resetting are impossible.</p> <p>Two causes are presumed for the above troubles: the electrical defect (faulty electronic parts, etc.) and the mechanical defect (incomplete contact or parts breakage).</p> <p>Have a check for the resetting mechanism switch spring and its related mechanism referring to 5 (Check of display switching mechanism).</p> <div data-bbox="505 709 886 1045" data-label="Image"> </div>		

No lamp lighting and no start-stop operation of reverse operation timer/stop watch

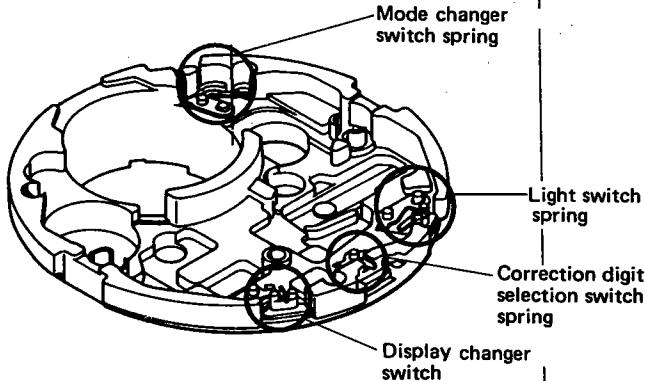
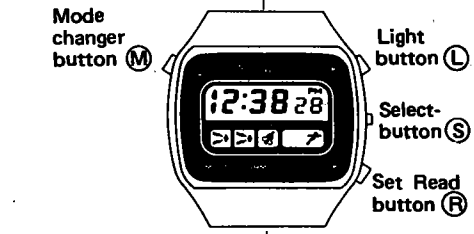
Check items	How to check	Results	Treatment
<p>10 Check of lamp mechanism and reverse operation timer/stop watch mechanism</p>	<p>The lamp does not light with a push of light-button (L), and no start-stop operation is secured under the display of the reverse operation timer and stop watch.</p> <p>Two causes are presumed for the above troubles: the electrical defect (faulty lamp) and the mechanical defect (incomplete contact, parts deformation or breakage).</p> <p>Have the checking for the above as follows.</p> <p>1. Take out the movement from the case. Switch the display from the normal indication to the reverse operation timer/stop watch indication. And have a conduction between the lamp switching spring and the LC display panel holder using a Metal tweezers as shown in the figure below. Under these conditions, examine whether the lamp lights and whether the reverse operation timer/stop watch has a correct operation.</p>  <p>2. Check of light Examine whether the lamp lights by applying Citizen Multi-tester to both terminals of the lamp attached to the supporter for plate complete, as shown in the figure below.</p> 	<p>Lamp lights, reverse op. timer/stop watch operates → Check of push-buttons</p> <p>No lamp light, no operation of reverse op. timer/stop watch → Replacement of plate, complete</p> <p>No lamp light, reverse op. timer/stop watch operates → Replacement of plate, complete</p> <p>No lamp light, no operation of reverse op. timer/stop watch → Check of switch spring</p> <p>Lamp lights → Check of switch spring</p> <p>No lamp light → Replacement of plate, complete</p>	

Check items	How to check	Results	Treatment
<p>11 Check of switch spring</p>	<p>Make sure whether the mode change-over switch spring, light switch spring, digit selection correcting switch spring and display change-over switch spring connection part is surely touching the gold-color pattern of the plate complete.</p> 		
<p>12 Check of operation-button</p>	<p>In case no trouble is detected in the electrical system (electronic circuit, etc.), it is decided the fault is caused by the trouble of the mechanical system. So that the following factors must be checked.</p> <ol style="list-style-type: none"> 1. Light button (L), select-button (S), read/set button (R) and mode changeover button (M) must be examined. 1) Make sure whether each push-button is actuated smoothly. 2) Make sure no dust or stains attach to each push-button. 3) Make sure each push-button has no bend. <p>Note: The check for 2) and 3) must be carried out with the push-buttons removed.</p>	 <p>Dust/stains attached → Removal</p> <p>Deformation/breakage detected → Replace of push-button</p>	

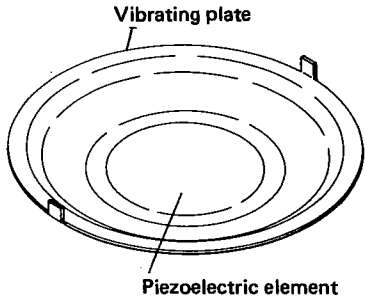
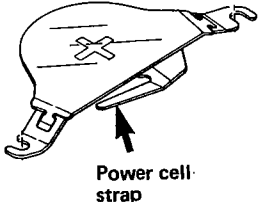
No Alarm Sound

Check items	How to check	Results	Treatment
<p>13 Check of alarm mechanism</p>	<p>1. Check of vibrating plate</p>  <ul style="list-style-type: none"> • Check whether the piezoelectric element has some crack. • Make sure the outer circumference of the piezoelectric element is adhered close to the vibrating plate. <p>2. Check of buzzer contact spring and power cell strap.</p> <ul style="list-style-type: none"> • Check whether the buzzer contact spring is worn out or deformed. • Check whether the arrow-marked area of the power cell strap is worn out.   <ul style="list-style-type: none"> • Make sure both the power cell strap and the buzzer contact spring have contact to the vibrating plate with proper pressure. 	<p>Crack or exfoliation of piezo-electric element</p> <p>Spring worn out or deformed</p> <p>Nothing wrong with above checks</p>	<p>Replacement of vibrating plate</p> <p>Replacement of buzzer contact spring</p> <p>Replacement of plate complete</p>

Common checking items

Check item	How to check	Results	Treatment
14 Measurement of power cell voltage	① Refer to the "measurement of the power cell voltage".	Over 1.5V Under 1.5V	⑮ Measurement of power consumption ⑮ Measurement of power consumption after replacement of power cell

15 Measurement of power consumption

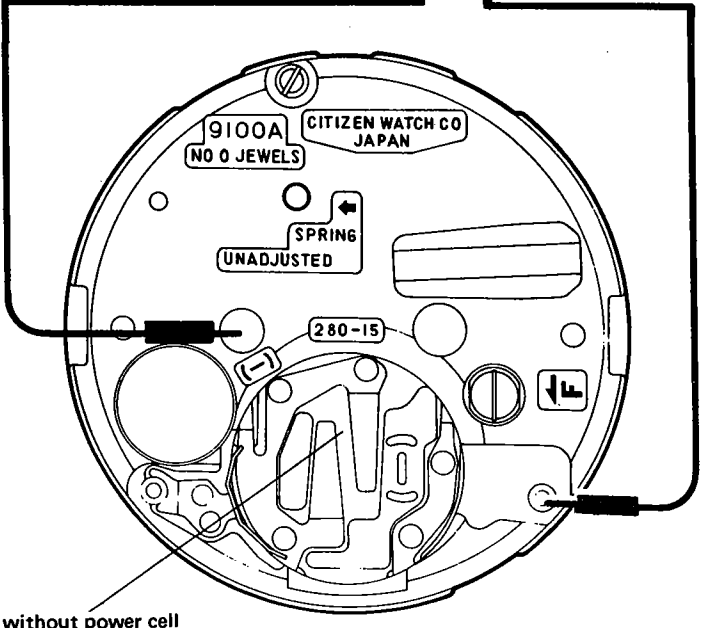
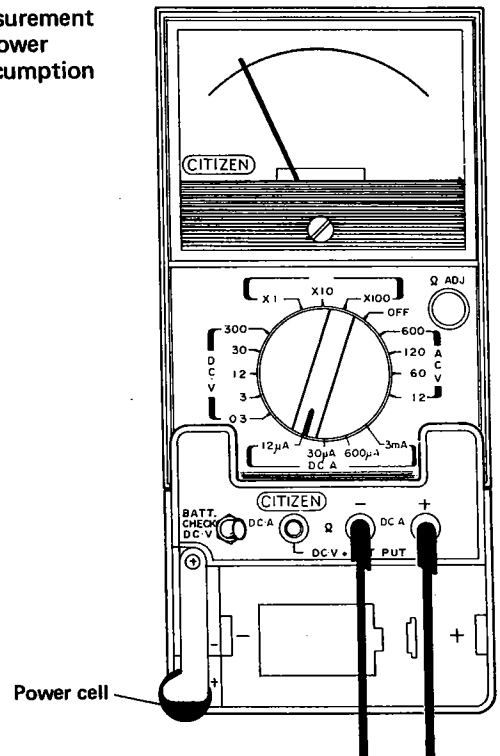

Results and treatment

(1) Measurement under normal condition:

Under 4.0μA
→ ⑯ Time adjustment



Over 4.0μA
→ (2) Measurement of power consumption of electronic circuit section

(2) Measurement of power consumption of electronic circuit section with LC display panel removed:

Under 2.5μA
→ Replace auxiliary rubber for electrical contact or LC display panel.

Over 2.5μA
→ Replace plate, complete.

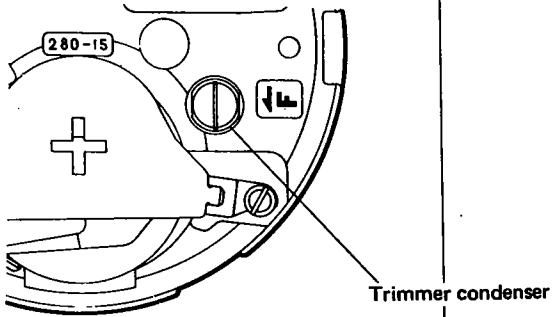
Note
Install the power cell more than 1.5V into the power cell holder of the adapter.

Check items	How to check	Results	Treatment
<p>16 Time adjustment</p>	<p>Set the microphone for liquid crystal to Quartz-timer and measure time rate.</p>  <p>The time rate adjustment can be performed by turning right or left the head of the screw for trimmer condenser.</p>		
<p>17 Check of appearance function</p>	<p>Check the appearance functions such as display condition of the time screen, quick setting of each display etc.</p> 		

CITIZEN WATCH CO., LTD.

Tokyo, Japan